



Inverted Metallurgical Microscopes ECLIPSE MA200/MA100



Inverted Metallurgical Microscopes  
**ECLIPSE**

**MA200**  
**MA100**  
**MA100L**

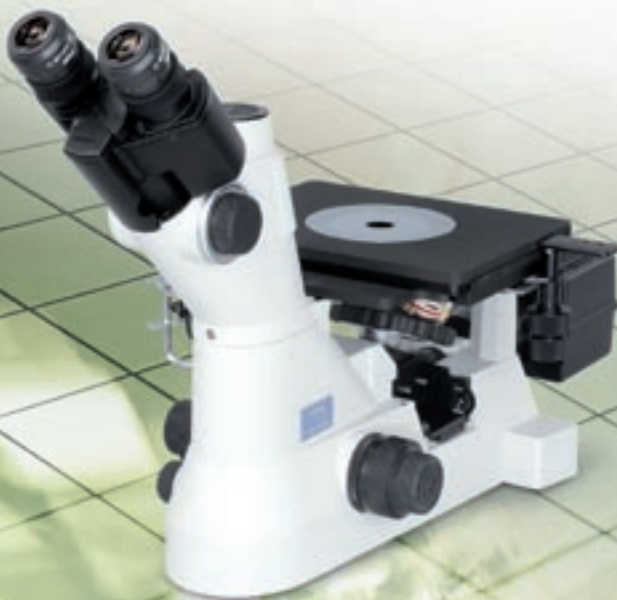

# MA200/MA100/MA100L

## Model features

Nikon offers 3 models of inverted metallurgical microscopes. The MA200 is designed for all the observation methods, The MA100/MA100L are designed for basic observation

bright field, dark field, simple polarizing, differential interference, and fluorescence observations. methods, bright field and simple polarizing observations.



### MA200

Thanks to its unique, solid-box structure, the MA200 offers high stability, durability, and a smaller footprint than conventional models as well as easy access to the stage handle, the nosepiece, BF/DF change lever, and diaphragms located at front side.

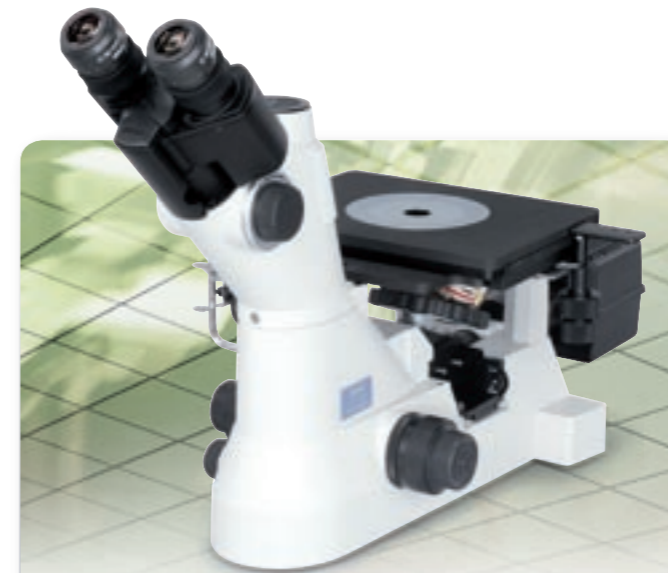

### MA100

The MA100/MA100L are compact, inverted microscopes designed for bright field and simple polarizing observations. Its small foot-print, rigid construction of its stage, easy operation, and superior Nikon optics, make it an ideal bench-top solution for: daily quality control of heat-treated metals, plastics, thin films, contaminants, chemicals, strain-tested materials, glasses, etc. MA100 with halogen light source and LED light source are available.

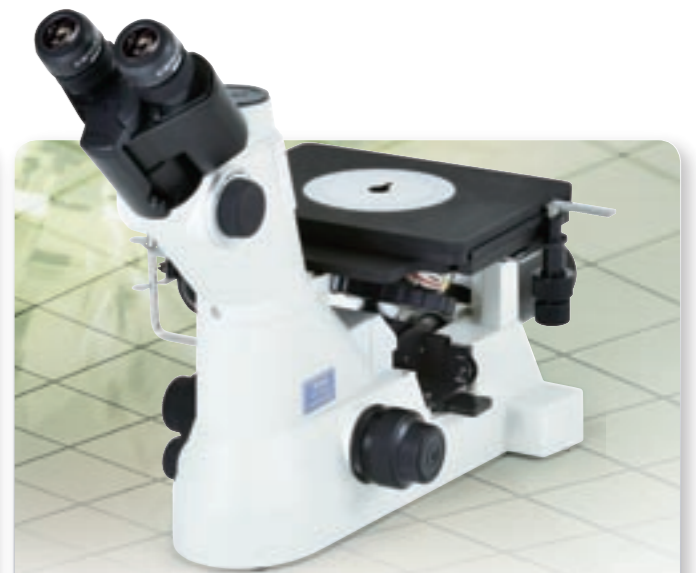

### MA100L NEW

Compatible observation methods	Brightfield	Darkfield	Simple polarizing	DIC	Fluorescence
	○	○	○	○	○
Compatible illuminators	<ul style="list-style-type: none"> <li>• LV-LH50PC 12V50W Halogen Lamp Illuminator</li> <li>• C-HGFI HG Precentered Fiber Illuminator (*option)</li> </ul>				
Magnification module	<ul style="list-style-type: none"> <li>• 1x/1.5x/2x</li> </ul>				
Compatible stages	<ul style="list-style-type: none"> <li>• MA2-SR Mechanical Stage (stroke: 50 x 50 mm)</li> </ul>				

\*DIA illuminator is available for transmitted light observation.

Compatible observation methods	Brightfield	Darkfield	Simple polarizing	DIC	Fluorescence
	○	—	○	—	—
Compatible illuminators	<ul style="list-style-type: none"> <li>• 6V30W Halogen Lamp Illuminator (internal power supply)</li> </ul>		<ul style="list-style-type: none"> <li>• 1W white LED Illuminator (internal power supply)</li> </ul>		
Magnification module	—				
Compatible stages	<ul style="list-style-type: none"> <li>• MA-SR Rectangular 3-plate Stage (stroke: 50 x 50 mm)</li> <li>• MA-SP Plain Stage</li> <li>• TI-SM Attachable Mechanical Stage CH (stroke: 126 x 80 mm)</li> </ul> <p>*Please use in combination with MA-SP plane stage.</p>				

\*Dedicated reflected illumination models.



# ECLIPSE MA200

New solution from Nikon:  
An ideal new microscope



## Front Operation

All controls are on the front of the instrument. Delivers ease-of-use by placing all important controls on the front.

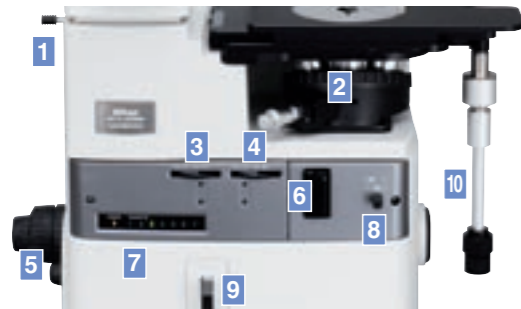

- |  |   |
|--|---|
| 1 Optical path changeover lever (vertical tube/binocular tube) | 6 Operation port for the polarizer/analyzer unit and the fluorescent unit |
| 2 Nosepiece  | 7 Display   |
| 3 Aperture diaphragm dial                                      | 8 BD field changeover lever   |
| 4 Field diaphragm dial   | 9 Scale slider slot   |
| 5 Brightness control dial                                      | 10 Flexible handle stage  |

### Quick Status Check

Automatically detects the address of the objective lens currently in use and displays it on the main unit front panel.

The observation position of the objective lens and sample can be checked easily from the microscope's front panel.

## Evolved Optical Performance

Basic performance dramatically improved. Provides a more ergonomic and clear image observation.

### Super-wide field of view

The ultra wide field of view eyepiece and with the combination of the newly developed 1x objective lens, a sample of 25mm diameter can be observed in an one field of view.

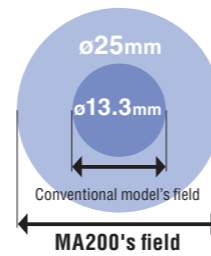

- T Plan EPI 1x
- Semi-Apochromat
- Wide field of view

### Even Illumination

Improved uniformity of illumination delivers clear images, especially for digital imaging.

### Combine up to eight images with the stitching feature

Combine up to eight images with the stitching feature. Get natural looking images with uniform lighting and no seams.



## Box Structure

Smaller footprint than conventional models: Three times free spaces left! Improved durability thanks to the unique box structure.

### Compact structure with a depth of 315 mm

A box shaped microscope, not only the width but also the depth is reduced dramatically: The foot print is only one-third of the conventional model!

### High stability/durability

Vibration during high-power observation is reduced. Extremely high rigidity.

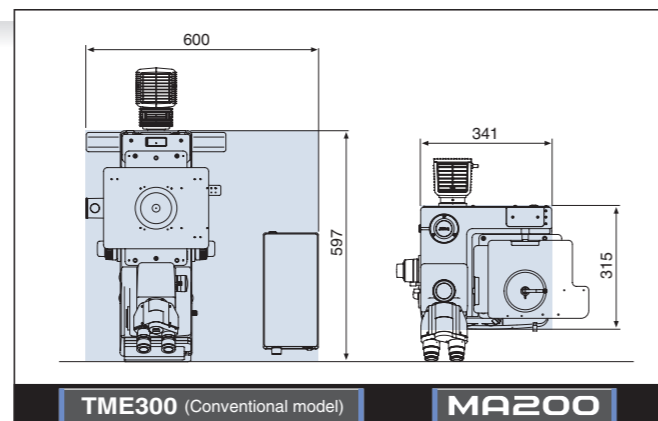

## Combination with Digital Camera

### Integration with digital camera for microscopy "Digital Sight series"

The MA200 allows detection of information and control of objective lenses via the camera control unit, enabling optimization of the conditions vital for image acquisition.

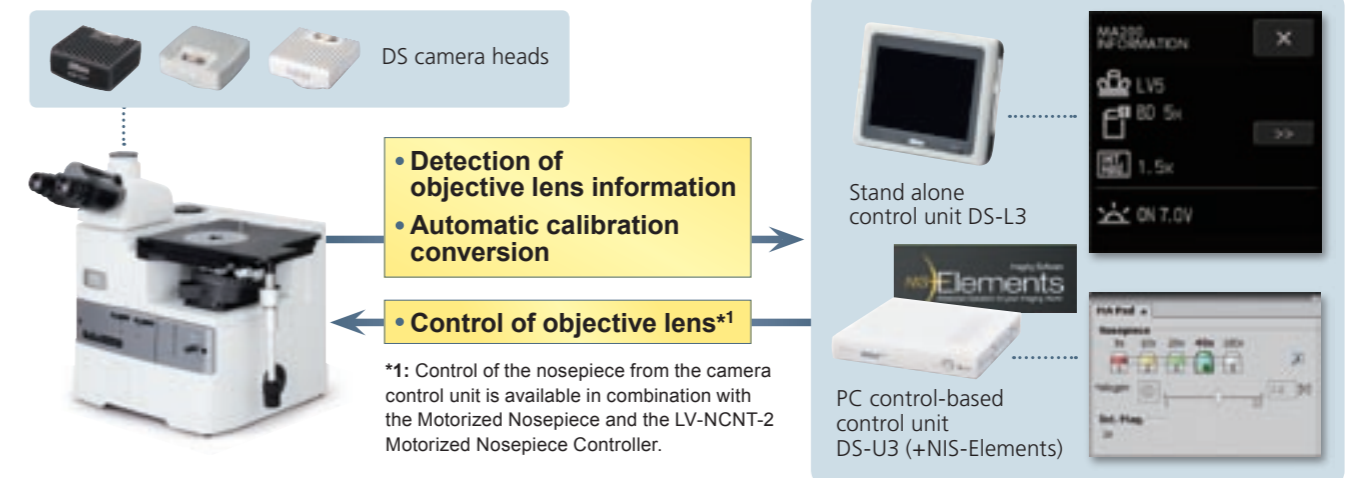

## Accessory

### Stage

The holder comes with a stage clip that enable sample rotation. This flexible handle stage delivers high durability needed to support heavy samples.

#### 1 MA-2 SR Stage

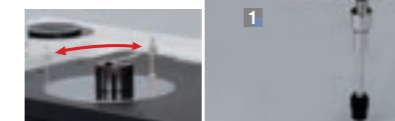

### Holders

We offer a full lineup of holders that correspond to a variety of sample shapes.



### Polarizing

Polarizing observation is effective for birefringence samples. MA2-PA unit is suitable for observation of aluminium.

#### • Single-action operation • Aluminium sample

Links the attachment/release of the analyzer/polarizer.

- 1 MA2-PA Unit
- 2 MA2-UPA Unit\*
- 3 MA2-λ P λ Plate

\*It is suitable for inspecting aluminium sample.

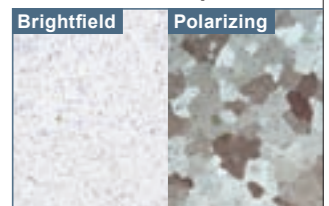

### DIC

You can choose standard or high contrast type DIC prism for best match to the sample. It is effective for observation of minute step heights.

- 1 MA2-PA Unit
- 2 L-DIHC DIC Prism (High Contrast)
- 3 L-DIC DIC Prism



### Nosepiece & Magnification Module

Enables communication of objective lens position, magnification and intermediate magnification module information with the DS-L3 control unit and NIS-Elements image software.

- 1 MA2-MC Magnification Module
- 2 MA2-NUI5 Universal Intelligent Quintuple Nosepiece

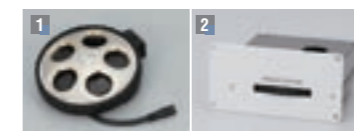

### Grain Size Reticle & Scale

Overlays a pattern onto the observed image. MA2-GR Grain Size Reticle is used for grain size analysis which is compliant to JIS G0551 and ASTM E112 standards. The MA2-MR Scale is used for scale display for each objective magnification.

- 1 MA2-GR Grain Size Reticle JIS G0551/objective lens 10x (100x magnification) ASTM E112/objective lens 10x (100x magnification)
- 2 MA2-MR Scale





# ECLIPSE MA100/ MA100L

Introducing a durable, user-friendly Inverted Microscope with, superior image quality, a small footprint, and great cost performance

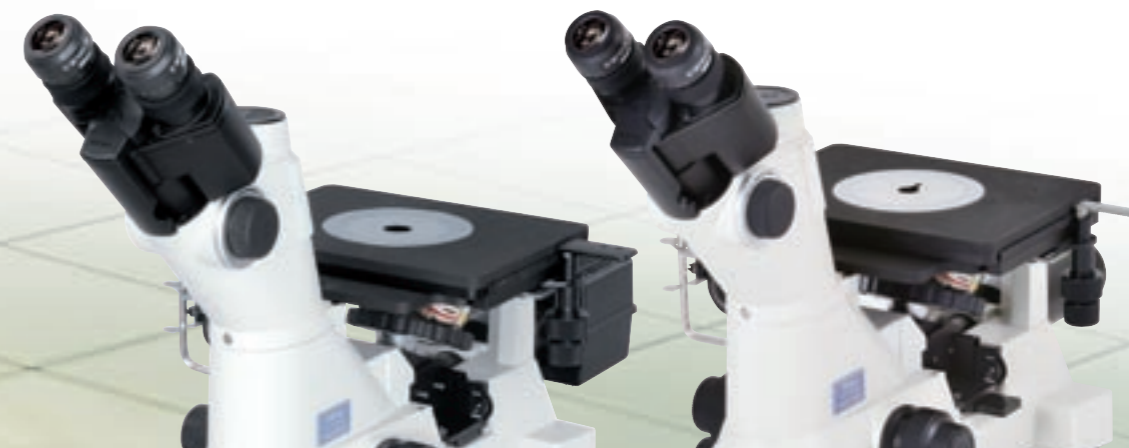

The ECLIPSE MA100 is a compact inverted microscope specially designed to meet the needs of reflected foot-print, durable construction, simple operation, and superior Nikon optics, make it an ideal bench-quality control/quality assurance applications.

light observations requiring either brightfield or simple polarization illumination techniques. Its small top solution for: metallurgical samples, electronic components, failure analysis, materials science and

## Illuminator

### MA100L with LED light source

The MA100/MA100L with LED light source is a new option. The bright LED light source features low power consumption and long life resulting in operating cost savings. A change in the intensity of the LED has less influence on color temperature than that of halogen lamp.

#### ● Halogen illuminator

The conventional MA100 with 6V30W halogen lamp is maintained for users wanting the spectrum of a halogen lamp for natural color.



LED illuminator (MA100L)

## CFI60-2

### Sharp, clear images using CFI60-2 optics

Nikon's CFI60 optical system, highly evaluated for its unique concept of high NA combined with long working distance has further evolved to achieve the apex in long working distance and chromatic aberration correction.



## Stage

### Stable control even with heavy samples A newly developed stage boasting superior durability

Nikon developed the new MA-SR Rectangular Stage especially for the MA100. The three-plate structure gives the microscope superior control and durability for observation of heavy samples, such as a grinder resin mounted samples.



## Aperture Diaphragm

### Aperture diaphragm comes standard

The epi illuminator comes standard with a variable aperture diaphragm to control image contrast and depth of field.



## Polarizer/Analyzer

### Simple polarization with a single-action polarizer/analyzer mechanism

MA2-PA Unit contains a polarizer and an analyzer for polarized light observation. The polarizer and analyzer can be shuttled in and out along the optical path by one single action. The polarizer can also rotate 360° to allow it to set the direction of polarization most suitable for a sample observed.



## Accessory



### Stage+Holders A

A simple fixed stage.

- 1 MA-SP Plain Stage
- 2 Acrylic Sample Holder (standard accessory / ø30mm aperture)
- 3 MA-SH3 Specimen Holder 3
- 4 MA-SRSH1 Universal Specimen Holder
- 5 Acrylic Sample Holder (standard accessory / crescent aperture)



### Stage+Holders B

A dual-platform stage.

- 1 TI-SM Mechanical Stage CH
- 2 C-HU Universal Holder
- 3 MA-SH1 Specimen Holder 1
- 4 MA-SH2 Specimen Holder 2

\*Please use in combination with MA-SP plane stage.

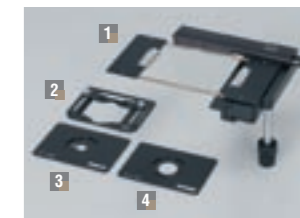

### Stage+Holders C

A triple-platform stage structure lets you use heavy samples.

- 1 MA-SR Rectangular Stage
- 2 Specimen Holder (standard accessory / ø20mm aperture)
- 3 MA-SH3 Specimen Holder 3
- 4 MA-SRSH1 Universal Specimen Holder
- 5 Specimen Holder (standard accessory / ø40mm aperture)



### Grain Size Reticle

The class of grain size in a sample can be easily distinguished while observing its image.

- 1 MA100-EPRGS Grain Size Reticle



### Simple Polarizing

An accessory necessary for simple polarization observation.

- 1 MA-P/A Simple Polarizer





# Accessory

## CFI60-2

Nikon's CFI60 optical system, highly evaluated for its unique concept of high NA combined with long working distance has further evolved to achieve the apex in long working distance and chromatic aberration correction.

Standard objective lenses

### TU Plan Fluor Series

EPI/BD 5x/10x/20x/50x/100x

These universal type standard objective lenses enable brightfield, darkfield, simple polarizing, sensitive polarizing, differential interference, and epi-fluorescence observation in one lens.



\* Depicted is the brightfield observation (EPI) objective lens.

Model	Magnification	NA	Working Distance (mm)
TU Plan Fluor EPI (brightfield type)	5x	0.15	23.5
	10x	0.30	17.5
	20x	0.45	4.5
	50x	0.80	1.0
TU Plan Fluor BD (brightfield/ darkfield type)	5x	0.15	18.0
	10x	0.30	15.0
	20x	0.45	4.5
	50x	0.80	1.0
100x	0.90	1.0	

Long working distance objective lenses

### TU Plan ELWD Series

EPI/BD 20x/50x/100x

Through the use of phase Fresnel lenses, these objective lenses enable long working distances while offering higher-level chromatic aberration correction than conventional objective lenses. This further improves operability for samples with differences in level.



\* Depicted is the brightfield observation (EPI) objective lens.

Model	Magnification	NA	Working Distance (mm)
TU Plan EPI ELWD (brightfield type)	20x	0.4	19.0
	50x	0.6	11.0
	100x	0.8	4.5
TU Plan BD ELWD (brightfield/ darkfield type)	20x	0.4	19.0
	50x	0.6	11.0
	100x	0.8	4.5

Low-magnification objective lenses

### T Plan EPI EPI 1x/2.5x

These low-magnification objective lenses enable clear observation using a conventional analyzer/polarizer, as well as operability-oriented observation without need for an analyzer/polarizer.



Model	Magnification	NA	Working Distance (mm)
T Plan EPI (brightfield type)	1x	0.03	3.8
	2.5x	0.075	6.5

Apochromatic objective lenses

### TU Plan Apo Series

EPI/BD 50x/100x/150x

By using phase Fresnel lenses, these objective lenses achieve significantly longer operating distances while maintaining the superior chromatic aberration performance of apochromatic lenses. A 50x lens is new to the line-up.



\* Depicted is the brightfield observation (EPI) objective lens.

\* Scheduled for sale from January 2013.

Model	Magnification	NA	Working Distance (mm)
TU Plan Apo EPI (brightfield type)	50x	0.8	2.0
	100x	0.9	2.0
	150x	0.9	1.5
TU Plan Apo BD (brightfield/ darkfield type)	50x	0.8	2.0
	100x	0.9	2.0
	150x	0.9	1.5

## Other Lens

Brightfield objective lens

### CFI L Plan EPI 40x

A 40x objective lens is best for metal analysis.

NA: 0.65 W.D.: 1.0mm



Stand alone control unit

## DS-L3

Equipped with a large touch panel monitor and a rich feature set, the DS-L3's ease of operation enables quick image acquisition even without a PC or computer monitor.



### High-definition touch panel monitor

Built-in 8.4" 1024 x 768 monitor. Easy to see and easy to use, the large touch-panel monitor allows simple setting and operation of the camera head with a touch of a finger or stylus.

### Scene mode

Optimal imaging parameters for each sample type and observation method can easily be set through the icons.

- Wafer/IC
- Metal, Ceramic/Plastic
- Circuit board
- Flat Panel Display

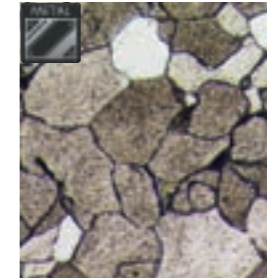

### A wide variety of tools

The DS-L3 enables the conducting of simple measurements on images, with input of lines and comments. These can also be written onto and saved with the image, and measurement data can be output.

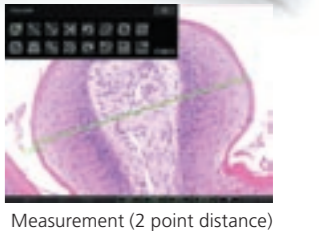

### Measurement function



### Position and size comparison functions

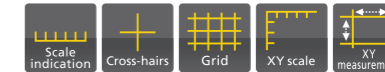

### Drawing functions



PC control-based control unit

## DS-U3

From display and shooting of live images to advanced image processing and analysis, the DS-U3 allows the control of all functions from a PC and is flexibly adaptable to a wide range of applications.



### Adaptable to a wide range of applications

Using NIS-Elements imaging software, you can perform image acquisition, processing, and analysis.

## NIS-Elements Comprehensive imaging software series

NIS-Elements series as control software. NIS-Elements allows functions from basic imaging to control of the microscope and peripheral devices to be performed, as well as the measurement, analysis, and management of acquired images.

### Large image

Stitches together images from multiple fields of view during shooting to create an image with wide field of view. Images already acquired can also be stitched together.

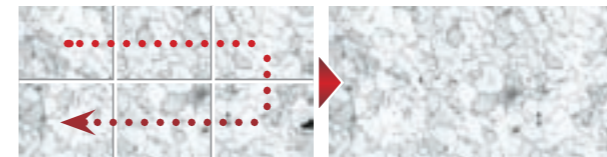

### Manual measurement and image annotation

Manual Measurement allows easy measurement of length and area by drawing lines or an object directly on the image. The results can be attached to the image, and also exported as text or to an Excel spreadsheet.

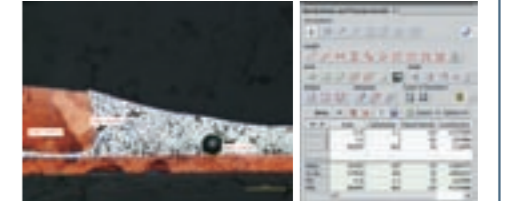

### Grain size analysis

Detects and measures grains in one and two phase samples according to JIS G0551 or ASTM E112-96/E1382-97 standards.



### Cast iron analysis

Detects, measures and classifies graphite content as well as ferrite content in graphite-corrected samples according to JIS G5502 or ASTM A247-06 standards.



\* See the "Digital Camera Digital Sight Series for Microscopes" catalog for details on Digital Sight features.

# System Diagram (MA200)

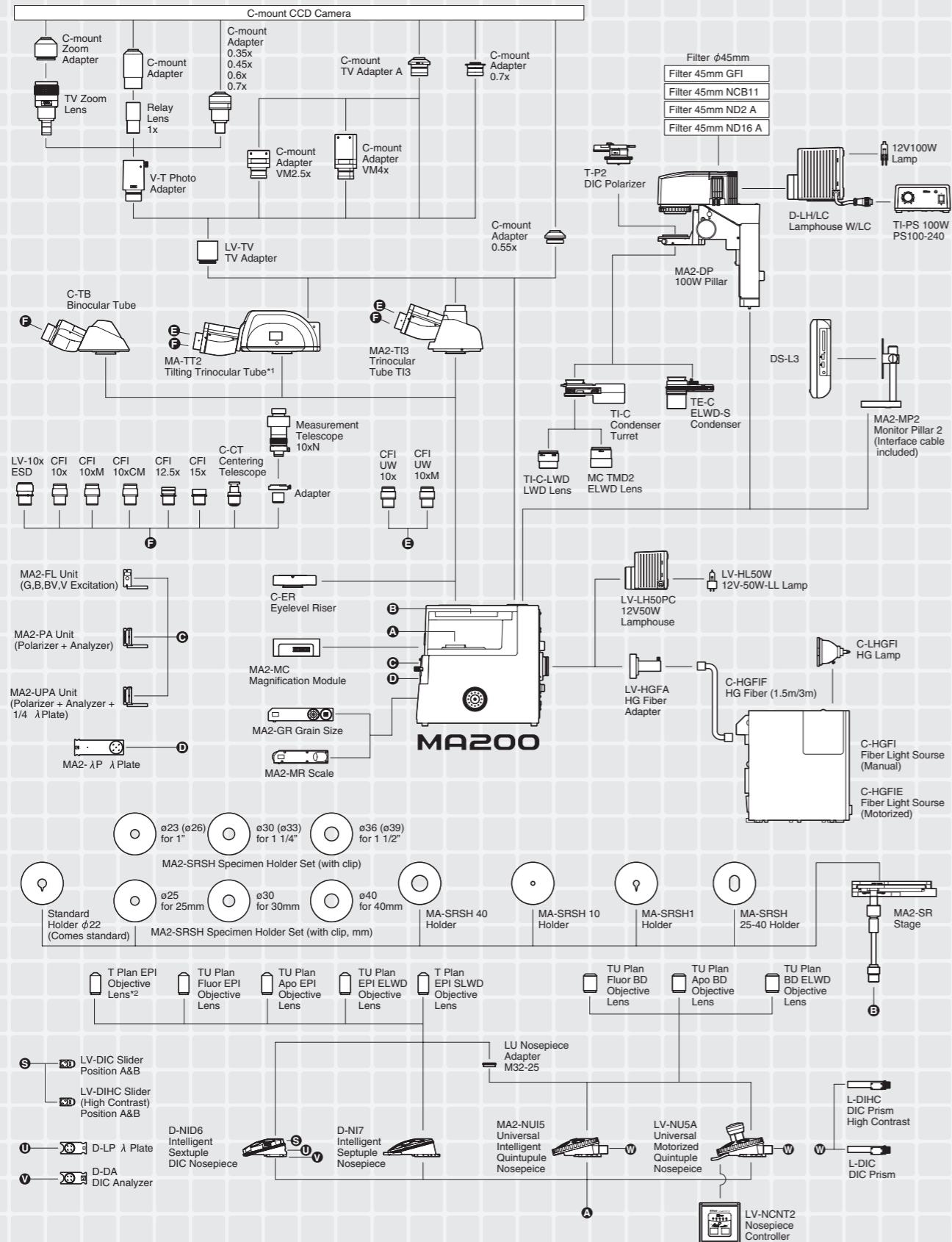

\*1: Built to order.  
\*2: T Plan EPI 1x/2.5x enable clear observation using a conventional analyzer/polarizer, as well as operability-oriented observation without need for an analyzer/polarizer.

# System Diagram (MA100/MA100L)

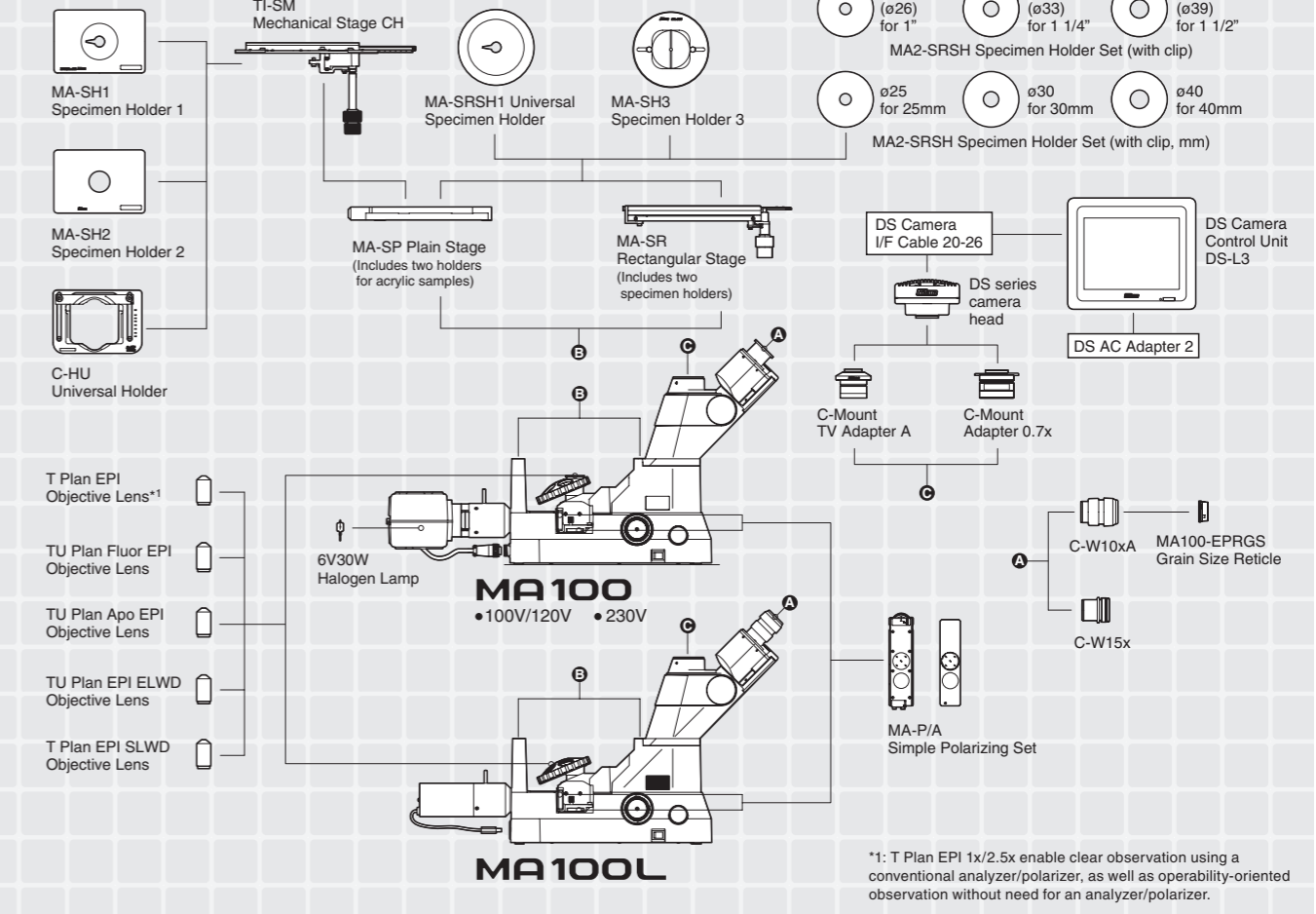

\*1: T Plan EPI 1x/2.5x enable clear observation using a conventional analyzer/polarizer, as well as operability-oriented observation without need for an analyzer/polarizer.

# Dimensions

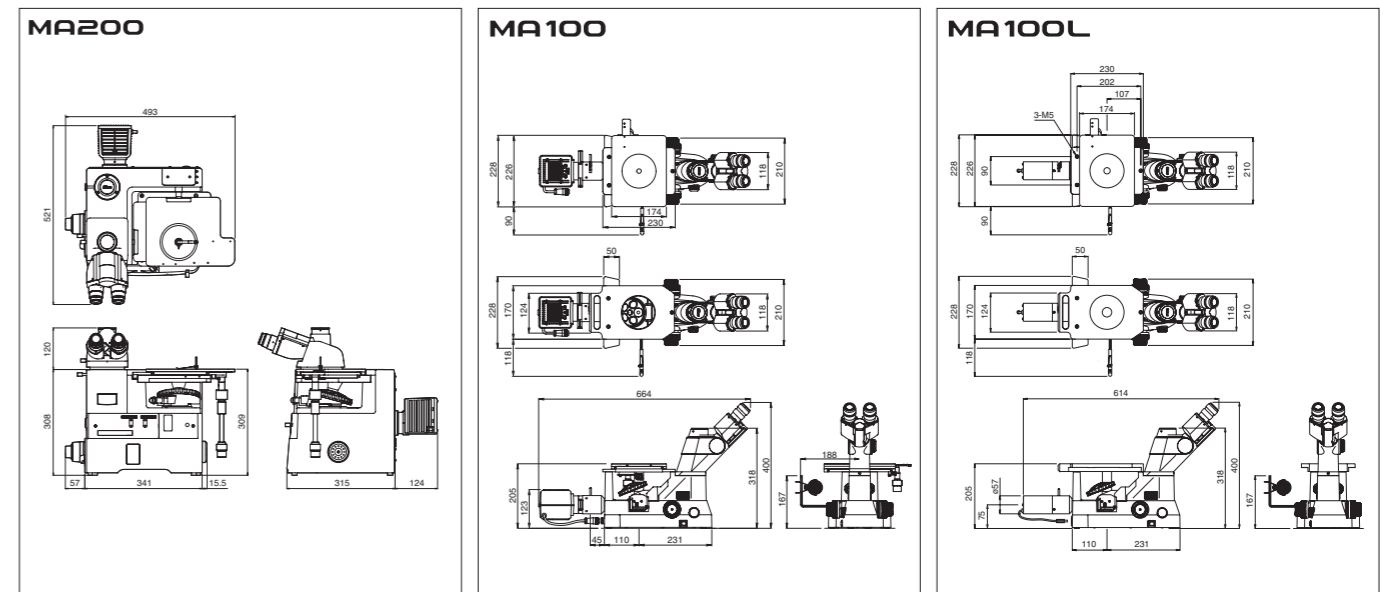



## Specifications (MA200)

		MA200
<b>Main body</b>	<b>Focusing mechanism</b>	Focusing nosepiece (Fixed stage) Coaxial coarse/fine adjustment knob (torque adjustable) Coarse adjustment of 4.0 mm per rotation, fine adjustment of 0.2 mm per rotation
	<b>Illumination</b>	With flare prevention, Built in UV cut filter Field diaphragm: dialing continuous variable (centerable), Aperture diaphragm: dialing continuous variable (centerable) Filter: Double turret (ND16, ND4/GIF, NCB, Additional option available), Polarizing block (Selectable with or without 1/4 $\lambda$ Plate) Fluorescence filter blocks: B/G/V/BV, Built in 12V50W halogen lamp, C-HGFI HG Fiber Illuminator
	<b>Light distribution</b>	Eyepiece tube/Back port: 100/0, 55/45
	<b>Optics</b>	CFI60/CFI60-2 system
<b>Observation image</b>	Surface Image	
<b>Observation method</b>	Bright/Darkfield/Simple Polarizing/DIC/Epi-Fluorescence	
<b>Revolving nosepieces</b>	MA2-NUI5: Bright/Darkfield/DIC 5 position nosepiece, LV-NU5A: Motorized Bright/Darkfield/DIC 5 position nosepiece D-NID6: Bright/Darkfield 6 position nosepiece (Intelligent), D-NI7: Brightfield 7 position nosepiece (Intelligent)	
<b>Stage</b>	MA2-SR Mechanical Stage (X/Y flexible handle) Dimension: 295 x 215mm, Stroke: 50mm x 50mm (with distance graduation), Standard accessory: $\phi$ 22 universal specimen holder (with sample clip)	
<b>Trinocular eyepiece</b>	Seidentopf, interpupillary distance adjustment 50-75mm	
<b>Power input</b>	100-240V, 50-60Hz	
<b>Electric power consumption</b>	1.2A 75W	
<b>Weight</b>	Approx. 26 kg (depends on combination)	
<b>Option</b>	<b>Intermediate magnification</b>	Turret (1x, 1.5x, 2x), Status detection (Output magnification information to main unit)
	<b>Scale</b>	MA2-GR Grain Reticle (ASTM E112-63 grain sizing numbers 1 to 8), Grid Reticle (20 lines, 0.5mm) MA2-MR Scale Reticle (compatible with 5-100x, Read in $\mu$ m, Dialing System)

## Specifications (MA100/MA100L)

	MA100	MA100L
<b>Optics</b>	CFI60/CFI60-2 system	
<b>Observation image</b>	Reversed image	
<b>Observation method</b>	Brightfield and polarization (with MA P/A simple polarizer/analyzer set)	
<b>Focusing</b>	Focusing nosepiece (fixed stage), coaxial coarse/fine adjustment knob with 8.5-mm stroke (Coarse adjustment of 37.7mm per turn, fine adjustment of 0.2mm per turn)	
<b>Nosepiece</b>	Brightfield 5-position nosepiece	
<b>Stage</b>	<b>MA-SR Rectangular 3-plate Stage</b> 50 x 50 mm stroke (includes two stage inserts ( $\phi$ 20mm and 40mm opening) and coaxial control handle on the right side The 3-plate design allows entire top surface to move. Optional Stage inserts: MA-SRSH1 Specimen Holder 1 with ( $\phi$ 15mm opening or MA-SH3 Specimen Holder 3 with 2mm to 32mm adjustable opening <b>MA-SP Plain Stage</b> 170 x 230mm - Includes two stage inserts (1) clear acrylic stage insert with $\phi$ 30mm opening, (2) clear acrylic stage insert with crescent opening (width 30mm) to allow clearance for rotation of high magnification objectives Optional stage inserts: MA-SRSH1 Specimen Holder 1 with 15mm opening or MA-SH3 Specimen Holder 3 with 2mm to 32mm adjustable opening Accepts Attachable Mechanical Stage TI-SM <b>TI-SM Attachable Mechanical Stage CH</b> 126mm x 80mm stroke, handle can be attached on the right or left side of the plain stage Optional Specimen Holders to fit Attachable Mechanical stage: MA-SH1 Specimen Holder 1 ( $\phi$ 15mm opening) MA-SH2 Specimen Holder 2 ( $\phi$ 30mm opening), or C-HU Universal Holder (30mm to 65mm adjustable opening)	
<b>Illuminator</b>	Internal power supply 6V30W Halogen Lamp (long-life type) Condenser built-in (Lever operated) $\phi$ 25mm filter (includes NCB11 and ND4) can be inserted	Internal power supply 1W white LED light source Condenser built-in (lever operated)
<b>Binocular body</b>	Built-in Siedentopf binocular, 45 inclination angle and 50 to 75-mm interpupillary adjustment	
<b>Power consumption (max.)</b>	42 W (nominal value)	3 W (nominal value)
<b>External dimensions</b>	230 x 664 x 381 mm (W x D x H)	230 x 614 x 381 mm (W x D x H)
<b>Weight</b>	8.4kg	7.2 kg

Specifications and equipment are subject to change without any notice or obligation on the part of the manufacturer. December 2012 ©2006/2007/2008/2009/2011/2012 NIKON CORPORATION

N.B. Export of the products\* in this catalog is controlled under the Japanese Foreign Exchange and Foreign Trade Law. Appropriate export procedures shall be required in case of export from Japan.

\*Products: Hardware and its technical information (including software)



**WARNING** TO ENSURE CORRECT USAGE, READ THE CORRESPONDING MANUALS CAREFULLY BEFORE USING THE EQUIPMENT.



### NIKON CORPORATION

Shin-Yurakucho Bldg., 12-1, Yurakucho 1-chome  
Chiyoda-ku, Tokyo 100-8331 Japan  
phone: +81-3-3216-2384 fax: +81-3-3216-2388  
<http://www.nikon.com/instruments/>



ISO 9001 Certified  
for NIKON CORPORATION  
Instruments Company



ISO 14001 Certified  
for NIKON CORPORATION  
Yokohama Plant

### NIKON METROLOGY, INC.

12701 Grand River Avenue, Brighton, MI 48116 U.S.A.  
phone: +1-810-220-4360 fax: +1-810-220-4300  
E-mail: [sales\\_us@nikonmetrology.com](mailto:sales_us@nikonmetrology.com)  
<http://www.nikonmetrology.com/>

### NIKON METROLOGY EUROPE NV

Geldenaaksebaan 329, 3001 Leuven, Belgium  
phone: +32-16-74-01-00 fax: +32-16-74-01-03  
Email: [sales\\_europe@nikonmetrology.com](mailto:sales_europe@nikonmetrology.com)  
<http://www.nikonmetrology.com/>

### NIKON INSTRUMENTS (SHANGHAI) CO., LTD.

CHINA phone: +86-21-6841-2050 fax: +86-21-6841-2060  
(Beijing branch) phone: +86-10-5831-2028 fax: +86-10-5831-2026  
(Guangzhou branch) phone: +86-20-3882-0550 fax: +86-20-3882-0580

### NIKON SINGAPORE PTE LTD.

SINGAPORE phone: +65-6559-3618 fax: +65-6559-3668

### NIKON MALAYSIA SDN. BHD.

MALAYSIA phone: +60-3-7809-3688 fax: +60-3-7809-3633

### NIKON INSTRUMENTS KOREA CO., LTD.

KOREA phone: +82-2-2186-8400 fax: +82-2-555-4415

### NIKON INDIA PRIVATE LIMITED

INDIA phone: +91-124-4688500 fax: +91-124-4688527

### NIKON CANADA INC.

CANADA phone: +1-905-602-9676 fax: +1-905-602-9953

### NIKON INSTRUMENTS S.p.A.

ITALY phone: +39-055-300-96-01 fax: +39-055-30-09-93

### NIKON METROLOGY UK LTD.

UNITED KINGDOM phone: +44-1332-811-349 fax: +44-1332-639-881  
E-mail: [sales\\_uk@nikonmetrology.com](mailto:sales_uk@nikonmetrology.com)

### NIKON METROLOGY SARL

FRANCE phone: +33-1-60-86-09-76 fax: +33-1-60-86-57-35  
E-mail: [sales\\_france@nikonmetrology.com](mailto:sales_france@nikonmetrology.com)

### NIKON METROLOGY GMBH

GERMANY phone: +49-6023-91733-0 fax: +49-6023-91733-229  
E-mail: [sales\\_germany@nikonmetrology.com](mailto:sales_germany@nikonmetrology.com)